



*SDA 4 / SDA 8*

数码信号放大分配器

*DMX Splitter*

中 / 英文使用说明书

Manual in Chinese/English

顾德电子有限公司

CODE ELECTRONIC CO., LTD.



CODE DMX 数码信号分配放大器专用于对 DMX512 数码灯光控制信号进行整形放大和分配输出，(SDA 4 分配输出 4 路, SDA 8 分配输出 8 路), 各输入输出接口采用高压隔离技术, 适用于 DMX512 信号经距离传输衰减后的整形放大处理, 以及各分配输出接口之间、输入接口与各分配输出接口之间需要完全的电气隔离的使用场合。由于各个接口之间互相独立隔离, 因此可以避免因控制线路、电脑灯、硅箱等问题而烧毁精密的数码灯光控制台, 确保数码灯光控制台的安全运行, 同时也保证 DMX 信号能正常传送至各种灯光设备, 从而提高整个数码灯光控制系统的可靠性。

## 技术参数

- 数码信号类型: DMX512, 以及采用 RS-485 接口传输的各种数码信号
- 1 路信号输入, 1 路直通信号输出 (信号输入与直通信号之间不经电气隔离)
- 4 路经独立电气隔离的信号分配输出 (SDA4 适用)
- 8 路经独立电气隔离的信号分配输出 (SDA8 适用)
- 接口类型: RS-485
- 信号连接插座: 输入 XLR-3-M, 输出 XLR-3-F
- 输入对输出、输出对输出的电气隔离耐压: >AC 300V
- 供电电源: AC220V/50Hz  $\pm$ 10%, 15W
- 尺寸: 19" 1U

## 设备面板图

### SDA 4 面板



### SDA 8 面板

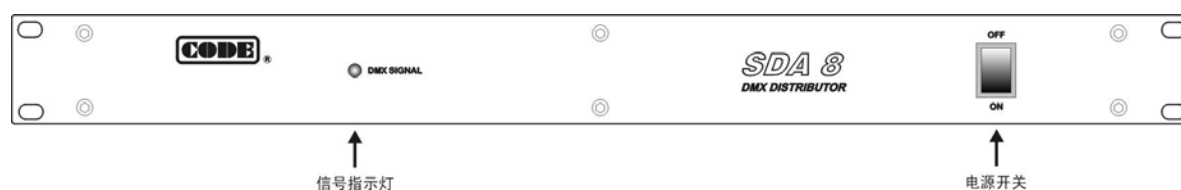

设备后板图

SDA 4 后板

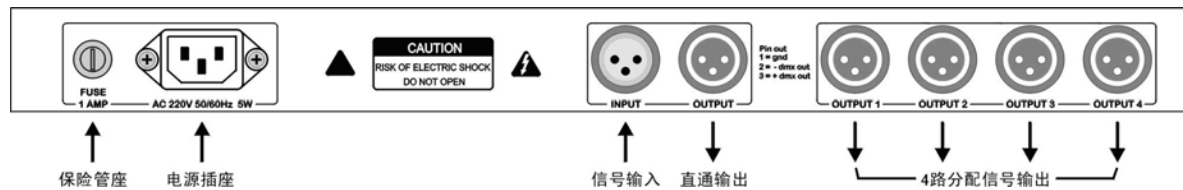

SDA 8 后板

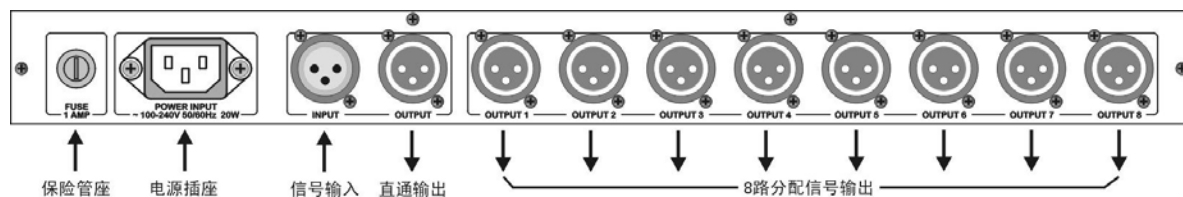

CODE 信号分配放大器应用方框图

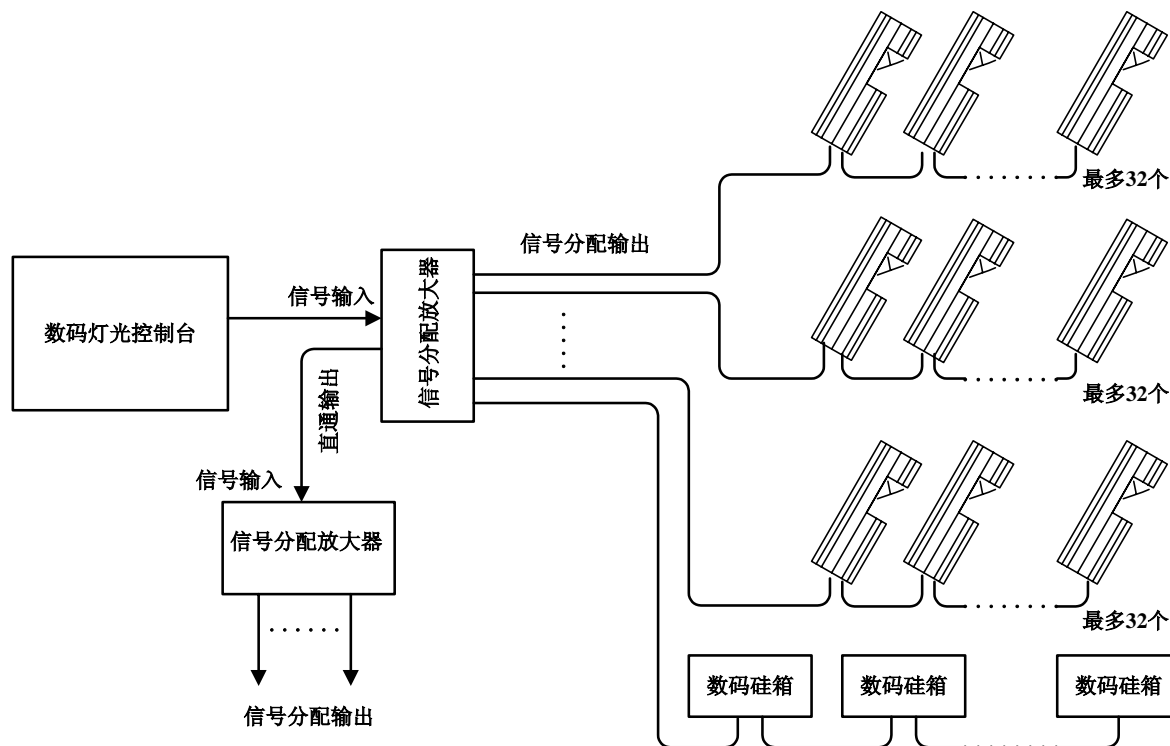

CODE DMX Splitter is special designed for multiply and revise DMX signal. The SDA 4 with 4 outputs and SDA 8 with 8 outputs. Each output with optical isolated.

The Splitter suits for any occasions, such as somewhere need to multiply and revise DMX512 signal that have been attenuated because of the long distance transfer, or somewhere need an absolute isolated signal between every input and output.

As a result that it can protect the DMX controller from damage that cause by control circuitry, intelligent fixtures or dimmer packs, as well as ensure the DMX controller run safety and the DMX signal transfer normally to each fixture. So that it makes the whole lighting control system more reliable.

### Technical specifications

- DMX512 signal, transfer multifarious digital signal with RS-485;
- 1 DMX input and 1 DMX thru output (without optically isolated);
- 4 DMX outputs with optical isolated, each output can connect with less than 32 fixtures (for SDA4) ;
- 8 DMX outputs with optical isolated, each output can connect with less than 32 fixtures (for SDA 8) ;
- Interface port: RS-485;
- Signal connector: Input XLR-3-M, Output XLR-3-F;
- Outputs are isolated from each other over 1000VDC;
- Power supply: AC100-240V 50-60Hz;
- Size: 19" 1U ;
- Net weight: approx 2.7Kg.

### FRONT PANEL

#### For SDA 4



#### For SDA 8



## REAR PANEL

### For SDA 4

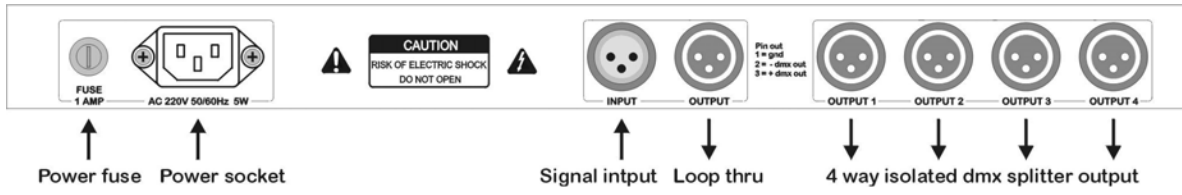

### For SDA 8

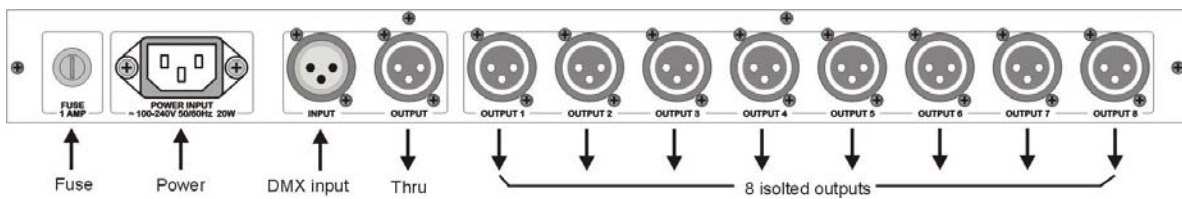

## CODE DMX Splitters APPLICATION EXAMPLES

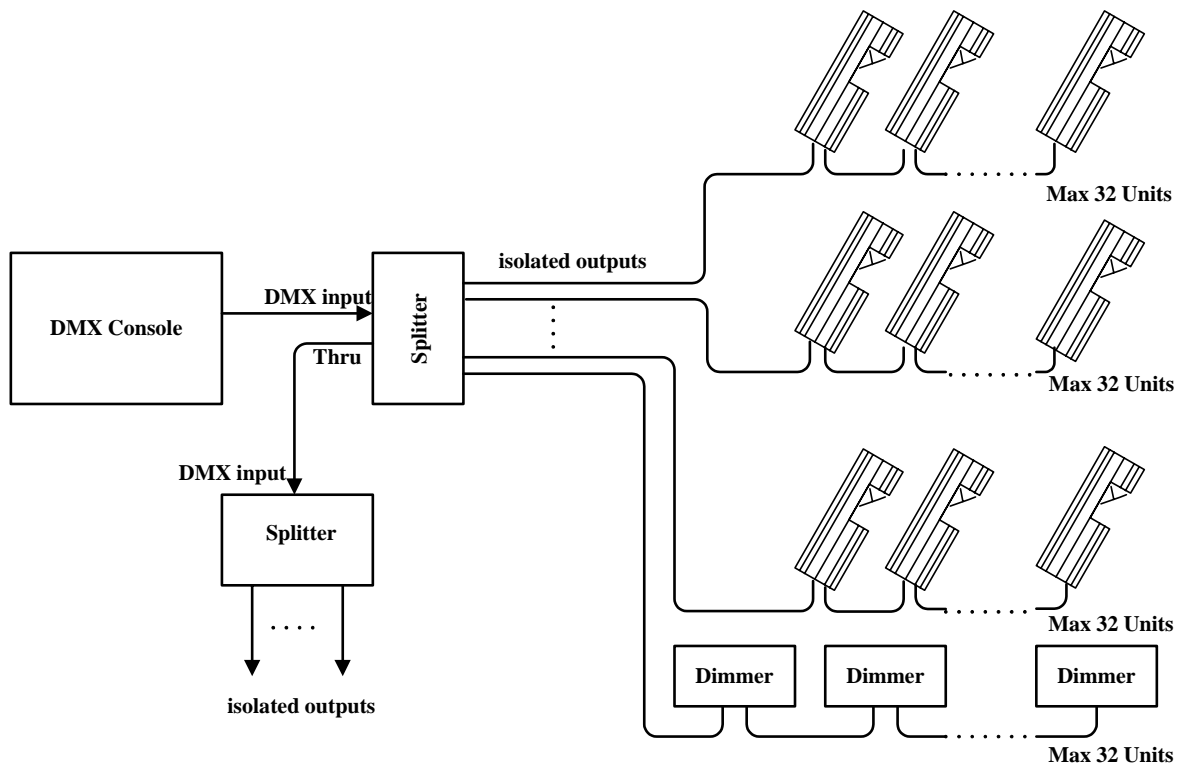

# MEMO



顾德电子有限公司

CODE ELECTRONIC CO., LTD.

---